

# FC161 Hand-held Fundus Camera

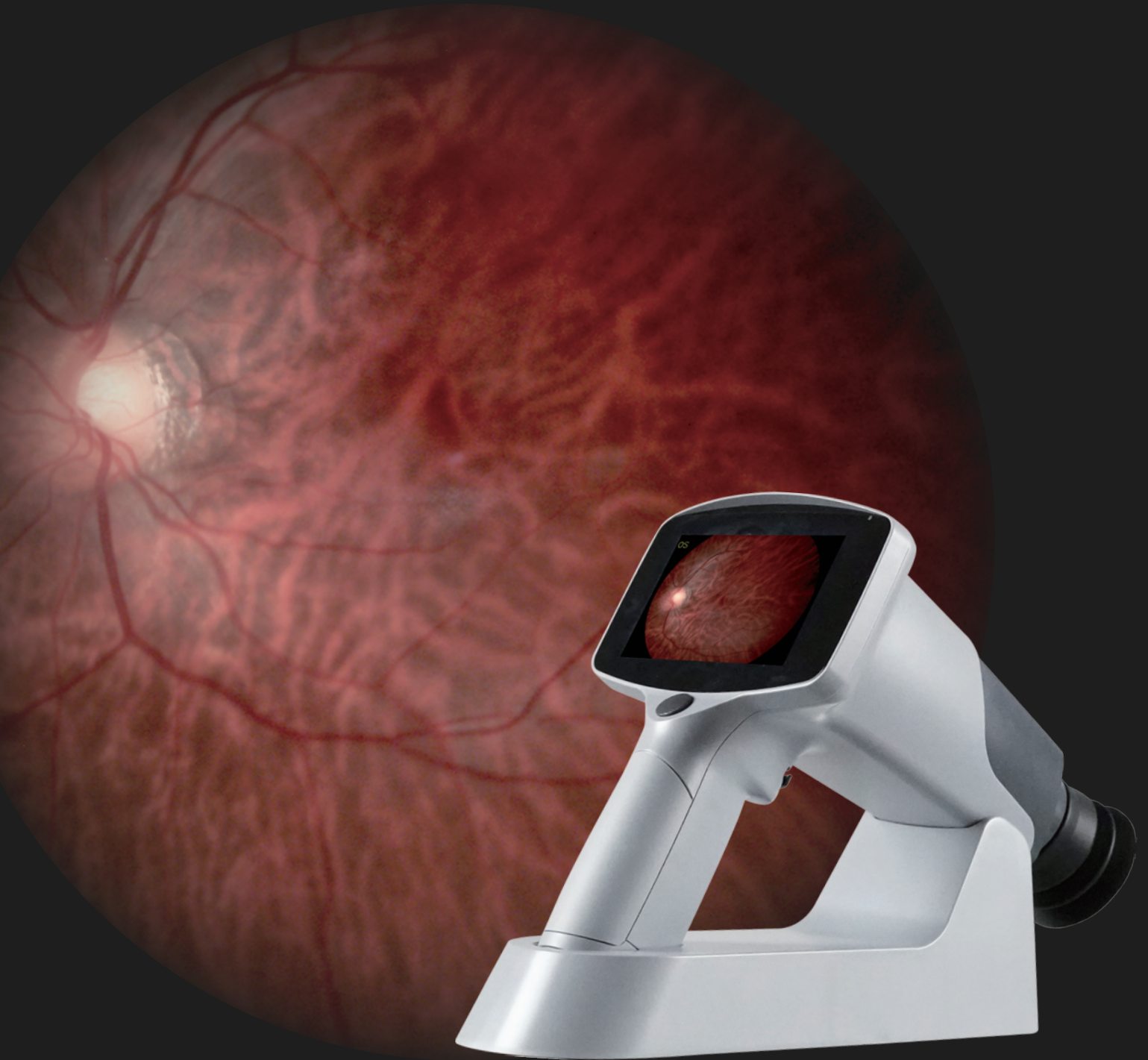

Millisecond Focusing

# Auto Split Focusing Technology

## Millisecond Focusing Speed

FC161 adopts Auto Split Focusing technology, focusing speed reaches milliseconds. It avoids the out-of-focus of the fundus image caused by the patient's movement during shooting, effectively improve the image quality and reduce the requirements for cooperation between operators and patients.

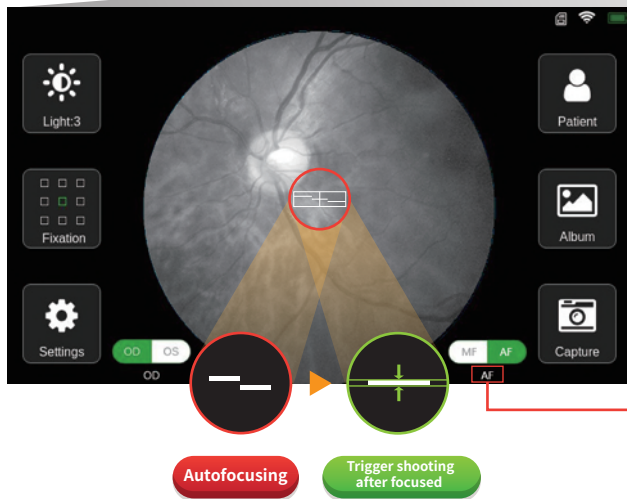
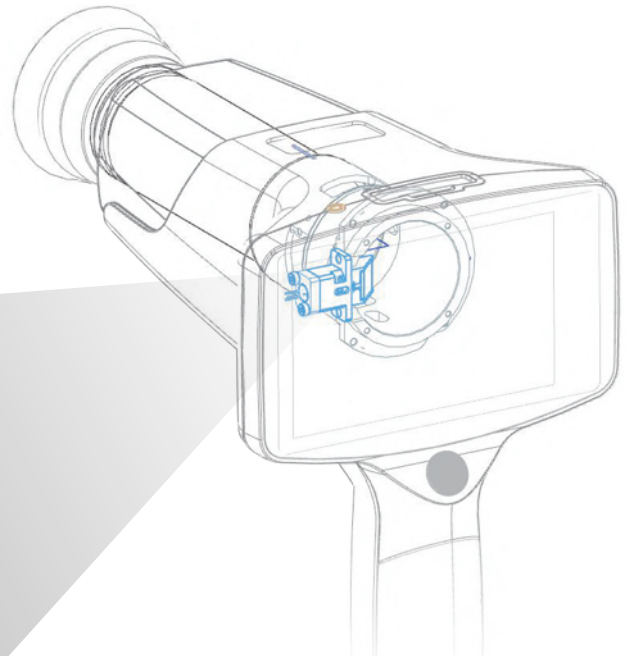

This function can be easily triggered by pressing the shooting button. FC161 will automatically recognize the infrared preview fundus image and trigger the internal mechanism to perform auto focus adjustment. For low-contrast focusing environments, the focus point can still be accurately locked on the details of the fundus.

MF Manual Focus AF Auto Focus

## 5 Advantages

### High Resolution

FC161 provides high resolution fundus images, image resolution is up to 12 Mega Pixels. It makes the diagnosis of early lesions more accurate and also essential for diagnosing retina disease, such as diabetic retinopathy, glaucoma and macular degeneration.

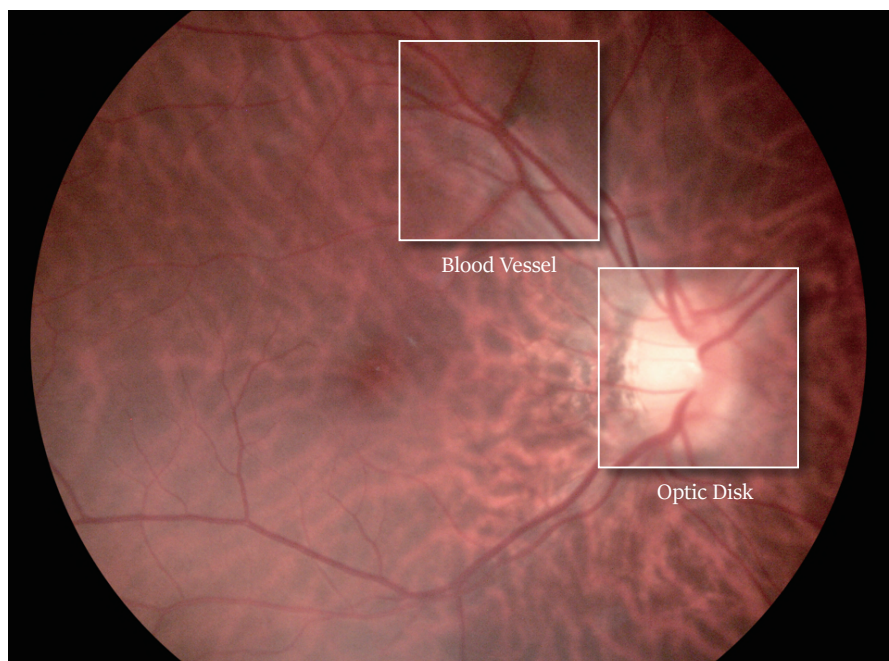

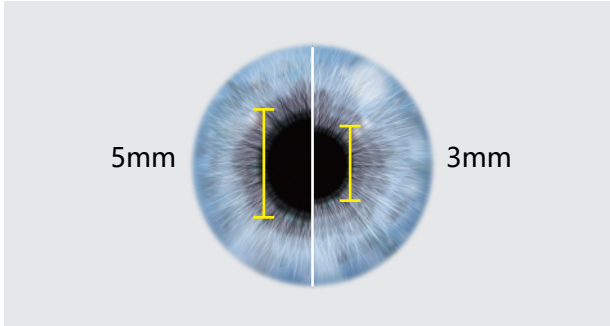

## Non-mydratiatic

The minimum pupil diameter of FC161 is  $\phi 3.0\text{mm}$ . 20 minutes of mydratiatic waiting time is saved, and the risk of mydrasiis to the patient is avoided.

## 9 Fixation Targets

With 9 fixation targets, FC161 covers  $85^\circ$  field of view of the fundus and supports the examination of early peripheral lesions of the fundus.

With  $45^\circ$  field of view, a single central fundus image can be taken to meet the needs of fundus disease screening.

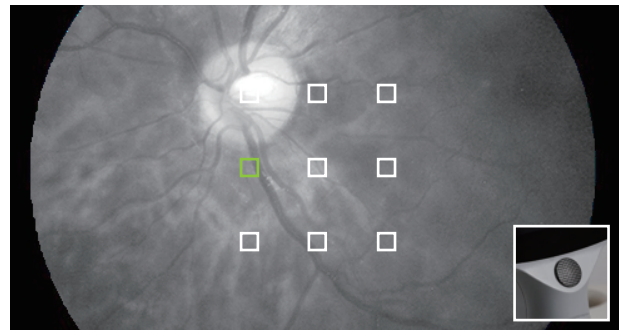

Easily select different fixation target by rotating direction key.

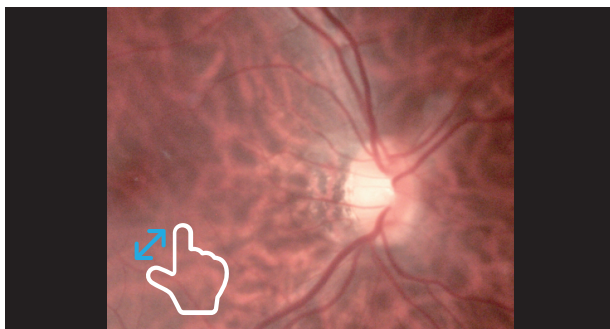

## Smart Touch Operation

4.3 " full-touch LED screen brings a smarter operating experience. Doctors can zoom the image at any time to check the details of the fundus, and can also easily slide the screen to edit and view the case.

## Real-time Uploading

FC161 supports real-time synchronization between fundus images and Mediview Patient Management software through WIFI connection.

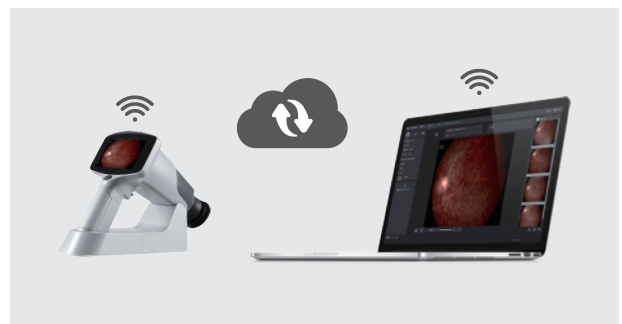



# Specification

	FC161
Type	Non-mydriatric
Filed of View	45degrees
Camera Sensor Resolution	12M Pixels
Fixation Targets	9×LED,Internal
Minimum Pupil Size	3mm
Illumination	White LED
Focusing	Manual/Automatic
Focus Range	-20D ~ +20D
Display	4.3" Touch Screen
Image Format	JPEG
Type of Image	Color
Memory	Micro SD card. Maximum 32G
Data Connectivity	WIFI/USB
Power Supply	Rechargeable battery 3.7V/3400mAh x 2
Working Time	6 hours
Charging Station	100-240V ~ , 0.5A, 50/60Hz
Power Supply	5V DC,2A
Dimensions	28cm×13cm×15cm
Weight	800g
languages	Chinese, English

## Standard Accessories



Carrying Case



Hand-held Fundus Camera



Recharging Station



Protection Cover



Power Adaptor



USB Cable



Mediview Patient Management Software

## Optional Accessories



Slit Lamp Attachment



## Shanghai MediWorks Precision Instruments Co.,Ltd.

Add:Building 7, Ming Pu Plaza, No. 3279, San Lu Rd, Min Hang District,Shanghai, 201100,China  
 Tel: +86-21-54260421 54260423 Fax:+86-21-54260425  
 Email: Marketing@mediworks.biz  
 International@mediworks.biz

Follow Us on



[www.mediworks.biz](http://www.mediworks.biz)